



Microwave Technology, Inc.

2013-2014 Product Selection Guide



Wideband 2-20 GHz

MMICs

Standard & Custom

Low Noise 1-12 GHz

Avionics

GaN High Power Amplifiers

WiMax 802.16

Broadband 6-18 GHz

Low Phase Noise

Industrial

Space

CATV

Low Noise

Gunn Diodes

0.5dB NF FET Chips

Ultra High Linearity

Military

HBT

Amplifiers and Modules

PHEMT

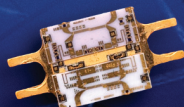

Linear FET

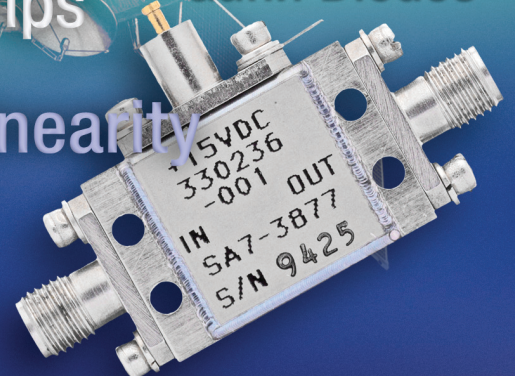

29 Years of Technical Expertise and Innovation

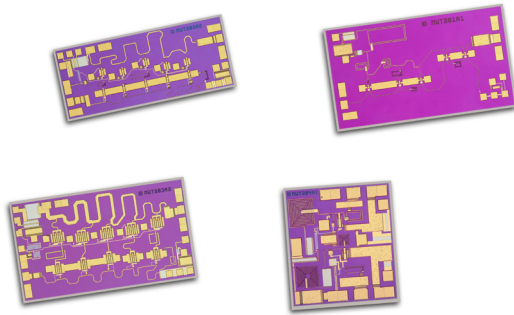

- High Performance/Quality MMIC Based on InGaP HBT, pHEMT, and Linear MESFET Technologies
- High Linearity, Fully Matched WiMax Power Amplifiers
- High Linearity, Broadband Gain Blocks
- Military Screening Available on Hermetically Sealed Package Products
- Low Cost Commercial Products

VSAT and Point-to-Point Radio Applications High Power MMIC Amplifiers

Model	Freq. (GHz)	DC Power (W) To maintain IM3	Gain (dB)	P-1 (dBm)	P-3 (dBm)	IM3 (dBc) @Po=20dB m/tone	OIP3 (dBm) @Po=20dB m/tone	In/Out Return Loss (dB)	Package
MMA-273336	27-33	13.2W (6V 2.2A)	22	35.5	36.5	36	38	10	Chip
MMA-273336-R5	27-33	13.2W (6V 2.2A)	22	35.5	36.5	36	38	10	5x5 QFN
MMA-283136	28-31	12W (6V 2A)	22	35.0	36.0	40	40	10	Chip
MMA-283136-R5	28-31	12W (6V 2A)	22	35.0	36.0	40	40	10	5x5 QFN
MMA-374030	37-40	10.8W (6V 1.8A)	24	31.0	32.0	39*	38*	10	Chip
MMA-374030-R5	37-40	10.8W (6V 1.8A)	24	31.0	32.0	39*	38*	10	5x5 QFN

* AT +18dBm pertone

VSAT and Point-to-Point Radio Applications High Linearity MMIC Amplifiers

Model	Freq. (GHz)	DC Power (W) To maintain IM3 Level	Gain Typ/Min (dB)	P-1 (dBm)	P-3 (dBm)	IM3 (dBc) @Po=20dBm /tone	OIP3 (dBm) @Po=20dBm /tone	In/Out Return Loss (dB)	Package
MMA-070936-R5	7-8.5	18W (6W 3A)	28.5 / 28	34	36	50	45	15	5x5 QFN
MMA-121633-R5	12.5-15.5	8.4W (6V 1.4A)	23.5 / ---	32	34	44	42	10	5x5 QFN
MMA-273435-R5	27-34	8.8W (4V 2.2A)	20.5 / ---	32	34	45	43	10	5x5 QFN
MMA-445933H-02	4.4-5.9	---	29 / 33	33	---	---	45	10 / 7	02
MMA-495933-Q5	4.9-5.9	---	10.5 / 10	33	---	---	46	9.6 / 4.8	5x5 QFN

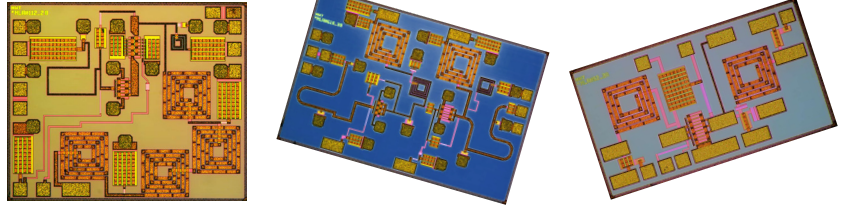

Driver Amplifiers

Model	Freq. (GHz)	DC Power (W) To maintain IM3 Level	Gain (dB)	P-1 (dBm)	P-3 (dBm)	Gain Flatness (dB)	OIP3 (dBm) @Po=10dB m/tone	In/Out Return Loss (dB)	Package
MMA-062020	6-20	0.6W (5V 0.12A)	13.5	18.3	19.5	+/- 1.0	28	10	Chip
MMA-062020-C3	6-20	0.6W (5V 0.12A)	13.5	18.3	19.5	+/- 1.0	28	10	3X3 QFN
MMA-174321	17-43	1.125W (4.5V 0.25A)	20.0	21.0	22.0	+/- 2.5	26	8	Chip
MMA-174321-R4	17-43	1.125W (4.5V 0.25A)	20.0	21.0	22.0	+/- 2.5	26	8	4x4 QFN

Traveling Wave Amplifiers

Model	Freq. (GHz)	DC Power (W) To maintain IM3 Level	Gain (dB)	P-1 (dBm)	P-3 (dBm)	Gain Flatness (dB)	OIP3 (dBm) @Po=10dB m/tone	In/Out Return Loss (dB)	Package
MMA-005022B	30KHz-50	1.4W (7V 0.2A)	15.5	22	25	+/- 1.0	37	10	Chip
MMA-005022-R4	30KHz-50	1.4W (7V 0.2A)	15.5	22	25	+/- 1.0	37	10	4x4 QFN
MMA-012030	0.1-20	6W (12V 0.5A)	12.5	27	29	+/- 0.5	37	10	Chip
MMA-012727	0.1-26.5	3.5W (10V 0.35A)	12.5	26	27	+/- 0.5	35	11	Chip
MMA-012727-R4	0.1-26.5	3.5W (10V 0.35A)	12.5	26	27	+/- 0.5	35	11	4x4 QFN

High Linearity Broadband Driver Amplifiers

Model	Freq. (GHz)	Linear Gain Typ/Min (dB)	Gain Flatness Typ/Max (+/-dB)	Input RL Typ (dB)	Output RL Typ (dB)	NF Typ (dB)	Pout @ -1 dB Typ (dBm)	Psat Typ (dBm)	OIP3 Typ (dBm)	Vd (V)	DC Current Typ/Max (mA)	Package
MMA-011015-C5	1-10	15 / ---	2.5 / -	10	10	4.0	15 / ---	17	---	6.0	75 / ---	5x5 QFN
MMA-021015	2-10	18 / ---	2.5 / -	-12	-15	4.8	17 / ---	---	---	6.0	89 / ---	Chip
MMA-053223-Q3	.5-3.2	12 / ---	1.5	10	10	3.5	24	---	42	6.0	120 / 200	3x3 QFN
MMA-054025	.5-4	11 / ---	1.0	10	10	3.5	25	---	44	7.5	--- / 350	Chip
MMA-054025-Q3	.5-4	11 / ---	1.0	10	10	3.5	25	---	44	7.5	--- / 350	3x3 QFN
MMA-053026-82	.9-2	--- / 11	--- / 2.0	10	8	3.0	26(min)	---	44	8.0	220 / 300	82



Broadband Low Noise Amplifiers

Model	Freq. (GHz)	Linear Gain Typ (dB)	Gain Flatness Typ (+/-dB)	Input RL Typ (dB)	Output RL Typ (dB)	NF Typ (dB)	Pout @ -1 dB Typ (dBm)	Vdd (V)	DC Current Typ (mA)	Package
MLA-01122B	1-10	17.0	1.0	14	11	1.6	16	5.0	55	Chip
MLA-01122B-C4	1-10	17.0	1.0	14	11	1.6	16	5.0	55	4x4 QFN
MLA-01122B-H6	1-10	17.0	1.0	14	11	1.6	16	5.0	55	H6
MLA-0522A	.2-1	17.0	0.5	12	20	1.0	16	3.0	70	Chip
	1-2	16.0	1.3	14	13	1.5	15	3.0	70	Chip
MLA-0522A-87	.2-1	17.5	1.0	10	11	1.0	15	3.0	65	87
	1-2	15.0	1.3	13	12	1.2	15	3.0	65	87
MLA-06183A	5-18	19.0	2.0	10	11	3.0	20	4.5	135	Chip
MLA-06183A-R4	5-18	19.0	2.0	10	11	3.0	20	4.5	135	4x4 QFN

High Linearity Driver Amplifiers for WiMax/WLAN

Model	Freq. (GHz)	Linear Gain Typ/Max (dB)	Gain Flatness Typ/Max (+/-dB)	Input RL Typ (dB)	Output RL Typ (dB)	NF Typ (dB)	Pout @ -1 dB Typ (dBm)	OIP3 Typ (dBm)	Vdd (V)	DC Current Typ/Max (mA)	Package
MMA-020624	2-4	17 / 15	1 / 1.5	12.0	12.0	3.0	25	40	8.0	250 / 300	Chip
	2-6	17 / 15	1 / 1.5	12.0	10.0	3.0	25	40	8.0	250 / 300	Chip
MMA-020624-L3	2-4	17 / 15	1 / 1.5	12.0	12.0	3.0	25	40	8.0	250 / 300	L3
	2-6	17 / 15	1 / 1.5	12.0	10.0	3.0	25	40	8.0	250 / 300	L3
MMA-020624-P3	2-4	17 / 15	1 / 1.5	12.0	12.0	3.0	25	40	8.0	250 / 300	P3
	2-6	17 / 15	1 / 1.5	12.0	10.0	3.0	25	40	8.0	250 / 300	P3
MMA-495930-Q4	4.9-5.9	20 / 18	1 / 1.2	8.0	8.0	---	30	45	7.5	450 / 500	4x4 QFN
MMA-495933-Q5	4.9-5.9	10.5 / 10	---	9.6	4.8	---	33	46	7.5	600 / ---	5x5 QFN

MwT has been providing components and semiconductor devices to the space industry since 1985. MwT performs assembly, testing, screening, and qualifications testing for microwave semiconductor devices, microwave components and subsystems based on MIL-PRF-38534 and according to military and government Hi-Rel standards such as MIL-PRF-38535, MIL-STD-202, MIL-STD-883, MIL-STD-750, MIL-STD-810, MIL-Q-9858, MIL-STD-19500 and MIL-I-45208.

Some of MwT's space qualified products are highlighted in this section.

Equivalent screening to MIL-PRF-38534 class H and K, and NASA programs.

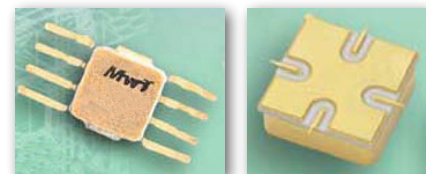

Space Qualified Low Noise Amplifiers

Model	Pkg/Chip	Freq (GHz)	Linear Gain Typ/Min (dB)	Gain Flatness Typ/MAX (±dB)	Input RL Typ (dB)	Output RL Typ (dB)	NF Typ (dB)	Pout @ -1 dB Typ (dBm)	OIP3 Typ (dBm)	Vdd (V)	DC Current Typ/Max (mA)
LN-162315-H4	H4	1.6-2.3	26	0.3	16	16	1.5	12	-	5	38
LN-141510-H4	H4	0.150	28	1.0	12	10	1.0	16	26	12	30
GM-141526-H4	H4	0.150	20	1.0	14	14	5.0	26	37	12	150

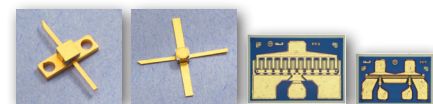

Space Qualified and Hi-Rel GaAs FETs

Model	Pkg/Avail.	Gate Width / Length (um)	Gate Layout Method	Gate Drain Source Bond Qty	Chip Thickness & VIA (mil.)	S.S. Gain @ 12 GHz Typ/Min (dB)	N.F. @ 12 GHz Typ/Min (dB)	Ga @ N.F. @ 12 GHz Typ/Min (dB)	P-1dB @ 12 GHz Typ/Min (dBm)	IP3 @ 12 GHz Typ/Min (dBm)	Chip Size (um - um)	Ideal Circuit
MwT-1	70, 71	630/0.3	single stripe	1, 1, 2	5, no	10.0 / 9.0	2.0 / -	7.0 / -	24.0/23.0	- / -	775 • 241	FB Amp
MwT-2	70, 71	630/0.3	single stripe	2, 2, 3	5, no	8.5 / 8.0	- / -	- / -	24.5/23.0	- / -	775 • 241	BA Amp
MwT-3	70, 71	300/0.3	single stripe	1, 1, 2	5, no	11.0 / 10.0	- / -	- / -	21.0/20.0	- / -	406 • 241	BA Amp
MwT-7	70	250/0.3	single stripe	2, 2, 2	5, no	10.5 / 10.0	2.0 / -	8.0 / -	20.0/18.0	- / -	356 • 241	BA/SE Amp
MwT-LP7	70	250/0.3	single stripe	2, 2, 2	5, no	10.5 / 10.0	2.0 / -	8.0 / -	20.0/18.0	- / -	356 • 241	Oscillator
MwT-PH7	70, 71	250/0.3	single stripe	2, 1, 2	4, no	13.5 / 12.0	- / -	- / -	24.0/22.0	- / -	356 • 241	Medium pow
MwT-8	71	2400/0.3	Interdigit	2, 2, 3	4, no	7.5 / 7.0	- / -	- / -	28.0/27.0	- / -	673 • 305	Power Amp
MwT-9	70, 71	750/0.3	Interdigit	1, 1, 2	5, no	9.0 / 8.0	2.0 / -	6.5 / 6.0	26.0/-	- / -	419 • 292	FB Amp
MwT-A9	70, 71	750/0.3	Interdigit	1, 1, 2	5, no	9.5 / 8.5	1.8 / -	6.5 / 6.0	25.5/23.0	- / -	419 • 292	FB Amp
MwT-PH7	70, 71	250/0.3	single stripe	2, 1, 2	4, no	13.5 / 12.0	- / -	- / -	24.0/22.0	- / -	356 • 241	Medium pow
MwT-H17	89, 71	2400/0.8	Interdigit	4, 4, 5	5, no	7.0 / 6.0	*	- / -	29.5/28.5	45/-	1130 • 279	BA/FB Amp

Capabilities

▪ Products Available for Space Screening

- GaAs FETs
- Microwave Bipolar Transistors
- Microwave Diodes
- Microwave Components such as hybrid amplifiers
- Microwave Subsystems
- Microwave Amplifiers

▪ Screening

- Element Evaluation, Group A, B, C, and D
- Assembly and 100% Screening
- Qualification Testing

▪ Testing

- DC and RF Parameters

▪ Program Management

- ISO Qualified Quality System

MwT Standard GaAs FETs / PHEMTs RF Properties (DC Properties Listed on the next page)

FETs*

Model	Package Available Sealed/ Hermetic	Gate Width/ Length (um)	Gate Layout Method	Gate Drain Source Bond Pads	Chip Thickness, VIA (mil)	S.S. Gain @ 12 GHz Typ/Min (dB)	N.F. @ 12 GHz Typ/Min (dB)	Ga @ N.F. 12 GHz Typ/Min (dB)	P-1dB @ 12 GHz Typ/Min (dBm)	IP3 @ 12 GHz Typ (dBm)	Chip Size (um - um)
MwT-1	70, 73 / 71	630 / 0.3	single stripe	1, 1, 2	5, no	10.0 / 9.0	2.0 / -	7.0 / -	24.0/23.0	-	775 • 241
MwT-2	70, 73 / 71	630 / 0.3	single stripe	2, 2, 3	5, no	8.5 / 8.0	- / -	- / -	24.5/23.0	-	775 • 241
MwT-3	70, 73 / 71	300 / 0.3	single stripe	1, 1, 2	5, no	11.0 / 10.0	- / -	- / -	21.0/20.0	-	406 • 241
MwT-4	70, 73 / N/A	180 / 0.3	single stripe	1, 1, 2	5, no	9.0 / 8.0	1.5 / 1.8	9.0 / 8.0	14.0/13.0	-	356 • 241
MwT-5	N/A / N/A	2 • 300 / 0.3	dual gate	3, 1, 2	5, no	13.0 / 12.0	3.5 / -	11.0 / -	19.0/15.0	-	406 • 241
MwT-7	70, 73 / N/A	250 / 0.3	single stripe	2, 2, 2	5, no	10.5 / 10.0	2.0 / -	8.0 / -	20.0/18.0	-	356 • 241
MwT-LP7 **	70, 73 / N/A	250 / 0.3	single stripe	2, 2, 2	5, no	10.5 / 10.0	2.0 / -	8.0 / -	20.0/18.0	-	356 • 241
MwT-8	71	2400 / 0.3	Interdigit	2, 2, 3	4, no	7.5 / 7.0	-	-	28.0/27.0	-	673 • 305
MwT-A9	70, 73 / 71	750 / 0.3	Interdigit	1, 1, 2	5, no	9.5 / 8.5	1.8 / -	6.5 / 6.0	25.5/23.0	-	419 • 292
MwT-A989	SOT-89	750 / 0.5	Interdigit	1, 1, 2	4, no	17.0/15.0 (1)	0.9 (1)	-	25.0/23.0	40	419 • 292
MwT-A989SB	SOT-89	750 / 0.5	Interdigit	1, 1, 2	4, no	17.0/15.0 (1)	0.9 (1)	-	25.0/23.0	40	419 • 292
MwT-10	N/A	83 / 0.3	single stripe	1,1,2	5, no	4.5 / 5.5	4.5 / 5.0	- / -	11.0/12.0	-	279 • 241
MwT-11	71	2400 / 0.3	Interdigit	2, 2, 3	4, no	9.0 / 7.0	-	-	30.0/28.0	-	775 • 343
MwT-H17	89 / 71	2400 / 0.8	Interdigit	4, 4, 5	5, no	7.0 / 6.0	(2)	-	29.5/28.5	45/-	1130 • 279
MwT-H22	71	4800 / 0.5	Interdigit	6, 6, 7	4, no	12.0 / 9.0	-	-	33.0/31.0	48	1651 • 508
MwT-H25	-	14400 / 0.5	Interdigit	6, 6, 7	4, no	10.0 / 9.0	-	-	37.5/36.0	48	2311 • 508
MwT-1789	SOT-89	2400 / 0.8	Interdigit	4, 4, 5	4, no	--	(3)	14.0 (1)	28.0	46	1130 • 279
MwT-1789SB	SOT-89	2400 / 0.8	Interdigit	4, 4, 5	4, no	--	(3)	18.0 (1)	28.0	44	1130 • 279
MwT-17Q3	QFN	2400 / 0.8	Interdigit	4, 4, 5	4, no	18.0/16.0 (1)	1.5 (1)	-	28.0/27.0	46	1130 • 279
MwT-PH4	70, 73 / 71	180 / 0.3	single stripe	1, 1, 2	5, no	11.0 / 10.0	1.2	13 / 12.0	20.0/18.0	-	356 • 241
MwT-PH5	-	300 / 0.3	single stripe	1, 1, 2	4, no	18.0 / 15.0	2.0 / -	12.0 / -	20.0/18.0	-	406 • 241
MwT-PH7	70, 73 / 71	250 / 0.3	single stripe	2, 1, 2	4, no	13.5 / 12.0	-	-	24.0/22.0	-	356 • 241
MwT-PH8	71	1200 / 0.3	Interdigit	2, 2, 3	4, no	10.0 / 9.0	-	-	30.0/29.0	-	673 • 305
MwT-PH9	70, 73 / 71	750 / 0.3	Interdigit	1, 1, 2	4, no	10.0 / 9.0	-	-	27.0/26.0	-	419 • 292
MwT-PH11	71	2400 / 0.3	Interdigit	2, 2, 3	4, no	9.0 / 7.0	-	-	32.0/30.0	42	775 • 343
MwT-PH15	70, 73 / 71	630 / 0.3	single stripe	3, 2, 5	4, no	12.0 / 10.0	-	-	28.5/27.0	-	775 • 241
MwT-PH16	71	900 / 0.3	single stripe	6, 2, 7	4, no	11.5 / 10.0	-	-	30.0/28.5	-	1067 • 241
MwT-PH16A	71	1600 / 0.25	Interdigit	4, 4, 5	4, no	11.0 / 9.5	-	-	31.0/29.0	-	1126 • 330

SB = Self-Biased

(1) @ 2.0GHz, (2) noise figure = 0.8dB @ 0.9GHz, (3) noise figure = 3.0dB @ 2.0GHz, (4) noise figure = 1.3dB @ 2.0GHz, (5) @ 4.0GHz

* Consult Factory for Available Packaging: 70 / 73 / 71 / 89 / Q3.

** Low Phase Noise

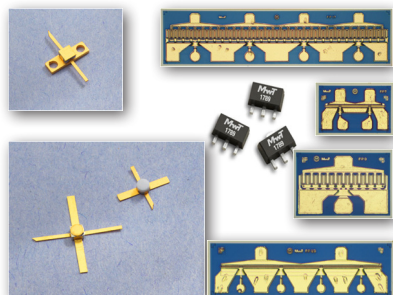

- Ultra Linear, High Dynamic Range, Low Phase Noise
- GaAs Process is Approved for Space Applications with Proven Reliability
- Commercial, Industrial, Military, and Space Grades
- Sample Bond Pull, Die Shear, Wafer DC Burn In, and Bake Tests for wafer evaluation per MILPRF-38534
- 100% Die Probe Test with Data Recorded
- 100% Visual Inspection (to level 1, 3, or 4)
- 100% Idss Match to Provide Performance Consistency
- RF Sample Test Capability Available Upon Request
- Standard and Custom Device Specifications
- Hi-Rel and Space-Rel Screening Options Available
JAN, JANTX, JANTXV, JANS
- RoHS (lead-free) Compliant Product Available
- Available in Chip and Package

MwT Standard GaAs FETs / PHEMTs DC Properties (RF Properties Listed on the previous page)

FETs* (cont.)

Model	Device Type	IDSS Range Min/Max (mA)	Gm Tested Vds/Vgs (V/V)	Gm Typ/Min (mS)	Vp Tested at Vds/Ids (V/mA)	Vp Typ/Max (-V)	Bvgso Tested lgs (-mA)	Bvgso Typ/Min (-V)	Bvgdo Tested lgs (-mA)	Bvgdo Typ/Min (-V)	Vds Absolute Max (V)	Chip Rth Typ (°C/W)	Ideal Circuit
MwT-1	MESFET	60 / 240	4.0 / 0.0	120 / 90	3.0 / 4.0	2.0 / 5.0	1.0	10.0 / 5.0	1.0	10.0 / 6.0	6.0	80	FB Amp
MwT-2	MESFET	60 / 240	4.0 / 0.0	100 / 75	3.0 / 4.0	2.0 / 5.0	0.4	12.0 / 6.0	0.4	12.0 / 8.0	7.0	80	BA Amp
MwT-3	MESFET	30 / 120	4.0 / 0.0	55 / 35	3.0 / 2.0	2.0 / 5.0	0.2	12.0 / 6.0	0.2	12.0 / 8.0	7.0	150	BA Amp
MwT-4	MESFET	18 / 66	3.0 / 0.0	35 / 27	3.0 / 1.0	1.5 / 4.0	0.2	8.0 / 5.0	0.2	8.0 / 6.0	6.0	250	Osc & Amp
MwT-5	MESFET	30 / 110	2.0 / 0.0	40 / 23	3.0 / 0.0	2.0 / 4.5	0.4	8.0 / 5.0	0.4	10.0 / 7.0	6.5	150	Buffer Amp
MwT-7	MESFET	26 / 98	3.0 / 0.0	45 / 36	3.0 / 1.0	1.5 / 4.5	0.4	8.0 / 5.0	0.4	8.0 / 6.0	6.0	180	BA/SE Amp
MwT-LP7	MESFET	38 / 98	3.0 / 0.0	45 / 36	3.0 / 1.0	1.5 / 4.5	0.4	8.0 / 5.0	0.4	8.0 / 6.0	6.0	180	Oscillator
MwT-8	MESFET	120 / 480	2.5 / 0.0	160 / 144	3.0 / 5.0	2.0 / 5.0	1.2	12.0 / 8.0	1.2	12.0 / 8.0	7.5	45	Power Amp
MwT-A9	MESFET	78 / 282	2.0 / 0.0	120 / 95	3.0 / 5.0	2.0 / 5.0	1.0	10.0 / 5.0	1.0	10.0 / 6.0	6.0	70	FB Amp
MwT-A989	MESFET	100 / 200	2.0 / 0.0	90 / 120	3.0 / 5.0	2.5 / 5.0	1.0	10.0 / 5.0	1.0	10.0 / 6.0	8.0	75	Power Amp
MwT-A989SB	MESFET	100 / 200	2.0 / 0.0	90 / 120	3.0 / 5.0	2.5 / 5.0	1.0	10.0 / 5.0	1.0	10.0 / 6.0	8.0	75	Power Amp
MwT-10	MESFET	8 / 30	3.0 / 0.0	12 / 16	3.0 / 0.5	1.5 / 4.0	0.1	4.0 / 7.0	0.1	5.0 / 7.0	5.0	450	BA Amp
MwT-11	MESFET	240 / 920	2.5 / 0.0	380 / 290	3.0 / 16.0	2.0 / 5.0	2.4	12.0 / 8.0	2.4	12.0 / 8.0	8.0	28	Power Amp
MwT-H17	MESFET	240 / 920	2.0 / 0.0	380 / 290	3.0 / 6.0	2.5 / 5.0	1.6	12.0 / 6.0	1.6	12.0 / 8.0	7.0	33	BA/BA Amp
MwT-H22	MESFET	800 / 1200	2.5 / 0.0	650 / 500	3.0 / 30.0	2.0 / 5.0	5.0	12.0 / 8.0	0.5	14.0 / 12.0	9.0	12	Power Amp
MwT-H25	HFET	2000 / 2600	2.5 / 0.0	1500 / 1000	3.0 / 150.0	2.0 / 5.0	14.0	12.0 / 8.0	14	16.0 / 14.0	12.0	60	Power Amp
MwT-1789	MESFET	440 / 680	2.5 / 0.0	380 / 290	3.0 / 16.0	2.0 / 5.0	2.4	12.0 / 6.0	2.4	12.0 / 9.0	8.0	35	High Linearity
MwT-1789SB	MESFET	440 / 680	2.0 / 0.0	380 / 290	3.0 / 16.0	2.5 / 5.0	2.4	12.0 / 6.0	2.4	12.0 / 9.0	8.0	30	Power Amp
MwT-17Q3	MESFET	440 / 680	2.5 / 0.0	380 / 290	3.0 / 16.0	2.0 / 5.0	2.4	12.0 / 6.0	2.4	12.0 / 9.0	8.0	35	Power Amp
MwT-PH4	PHEMT	18 / 66	2.5 / 0.0	58 / 36	3.0 / 1.0	1.2 / 2.5	0.4	12.0 / 6.0	0.4	12.0 / 8.0	7.0	210	Osc & Amp
MwT-PH5	PHEMT	40 / 120	2.5 / 0.0	60 / 40	3.0 / 2.0	1.2 / 2.5	0.4	12.0 / 6.0	0.4	13.0 / 10.0	7.0	150	Power Amp
MwT-PH7	PHEMT	50 / 122	2.5 / 0.0	80 / 50	3.0 / 1.0	1.2 / 2.5	0.4	12.0 / 6.0	0.4	12.0 / 8.0	7.0	150	Medium pow
MwT-PH8	PHEMT	240 / 600	2.5 / 0.0	320 / 240	3.0 / 8.0	1.2 / 2.5	1.2	12.0 / 6.0	1.2	13.0 / 10.0	8.0	40	Medium pow
MwT-PH9	PHEMT	120 / 292	2.5 / 0.0	200 / 150	3.0 / 5.0	1.2 / 2.5	1.0	12.0 / 6.0	1.0	13.0 / 10.0	8.0	56	Power Amp
MwT-PH11	PHEMT	440 / 800	2.0 / 0.0	800 / 450	3.0 / 16.0	1.2 / 2.5	2.4	12.0 / 6.0	2.4	13.0 / 10.0	8.0	24	Power Amp
MwT-PH15	PHEMT	120 / 240	2.5 / 0.0	200 / 130	3.0 / 2.0	1.2 / 2.5	1.0	12.0 / 6.0	1.0	13.0 / 10.0	8.0	65	Medium pow
MwT-PH16	PHEMT	150 / 360	2.5 / 0.0	280 / 180	3.0 / 3.0	1.2 / 2.5	1.0	12.0 / 6.0	1.0	13.0 / 10.0	8.0	45	Medium pow
MwT-PH16A	PHEMT	300 / 600	2.0 / 0.0	400 / 300	3.0 / 2.0	1.2 / 2.5	2.0	8.0 / 6.0	2.0	13.0 / 10.0	9.0	30	Medium pow

* Consult Factory for Available Packaging: 70 / 73 / 71 / 89 / Q3

NOTE: Consult Factory For Binning Ranges

Low Noise GaAs FETs

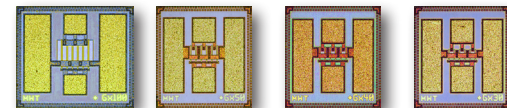

Model	Gate Width/Length (um)	NF @ 12 GHz Typ (dB)	NF @ 4 GHz Typ (dB)	Ga @ N.F @ 12 GHz Typ/Min (dB)	Ga @ N.F @ 4 GHz Typ (dB)	P-1dB @ 12 GHz Typ (dBm)
MwT-LN180	180 / 0.15	0.50	0.20	10 / --	14.5	16.0
MwT-LN240	240 / 0.15	0.50	0.20	10 / --	13.0	16.0
MwT-LN300	300 / 0.15	0.60	0.20	10 / --	13.0	16.0
MwT-LN600	600 / 0.15	0.50	0.20	9 / 8	12.0	20.0

GaAs FETs / PHEMTs / HFETs

MPS, ULA, WPS, and MGA

- Miniature, Low Cost, SMT, Flange, & Leadless Package Options
- Miniature, High Reliability, Hermetic SMT Options
- Low Noise, High Linearity, and Broadband Options
- Suitable for High Dynamic Range LNA Applications
- Suitable for High Linear Driver Amp Gain Stages
- Low VSWR for Improved Cascade
- Performance Wireless Amplifiers (MPS, ULA and WPS WiMax)
- Single Voltage Supply and Low Current Operation
- Most Parts are Eutectic Assembly for High Reliability
- Standard and Custom Amplifier Specifications
- Hi-Rel and Space-Rel Screening Available (class H and K)
- GaAs MESFET and GaN PHEMT Devices

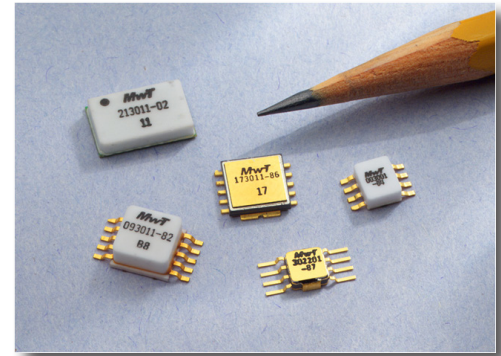

High Linearity MPS

Model	Case Code (-XX) Sealed SMT, Flange	Freq Range (MHz)	Linear Gain Typ/Min (dB)	Gain Flatness Typ/Max (±dB)	VSWR Input Typ/Max (dB)	VSWR Output Typ/Max (dB)	Noise Figure Typ/Max (dB)	Pout @ -1 dB Typ/Min (dBm)	IP3 Typ/Min (dBm)	DC Voltage Applied (V)	DC Current Typ (mA)
MPS-0030H16-XX	02	10-3000	14.5/16.0	0.50/0.80	2.0 / -	2.0 / -	-	27.0 / 25.5	33.5 / -	7.0-8.0	240-270
MPS-0325A9D-XX	82	300-2500	12.5/13.5	0.20/0.60	1.4 / 1.7	1.2 / 1.7	4.0 / -	25.0 / -	42.0 / 39.0	7.5	300-330
MPS-081017-XX	02	800-1000	15.0/14.0		2.0 / -	2.5 / -	-	28.5 / -	45.0 / 42.0	7.5	380-450
MPS-0810A9-XX	02	800-960	15.0/14.0		1.5 / -	2.0 / -	1.1 / 1.5	20.5 / -	34.0 / -	6.0	160-240
MPS-0810A9D-XX	82, -	800-960	14.0/13.0	0.20/0.30	1.4 / 1.5	1.2 / 1.5	5.0 / -	26.0 / 25.0	42.0 / 41.0	7.5	300-400
MPS-0820A9D-XX	02	800-2050	13.5/12.5		1.4 / -	1.4 / -	5.5 / -	24.0 / -	43.0 / -	6.0	220-280
MPS-093011-XX	82, 85, *	800-1000	16.0/14.0	0.25/0.50	1.5 / -	2.2 / -	6.0 / -	30.0 / -	45.0 / 43.0	7.5	380-450
MPS-1720A9-XX	02	800-960	14.0/13.0		2.1 / 2.2	1.5 / 2.1	1.1 / 1.5	20.0 / -	33.0 / -	6.0	100-140
MPS-172208-XX	82, 85	1900-2000	13.0/12.0	0.20/0.50	2.0 / 2.5	2.0 / 2.5	5.0 / -	26.0 / 25.0	38.0 / -	7.5	380-450
MPS-173011-XX	82, 85, *	1400-1700	14.0/13.0	0.25/0.50	1.5 / -	2.2 / -	6.0 / -	30.0 / -	45.0 / 42.0	7.5	380-450
MPS-1820A9D-XX	82, -, 02	1800-2000	14.0/13.0	0.20/0.30	1.4 / 1.5	1.2 / 1.5	5.0 / -	26.0 / 25.0	42.0 / 41.0	7.5	300-400
MPS-182117-XX	02	1800-2100	14.0/13.0		2.0 / -	2.5 / -	-	28.5 / -	45.0 / 42.0	7.5	380-450
MPS-182217-XX	82, -, 02	1800-2200	14.0/13.0	0.25/0.50	1.5 / -	3.0 / -	6.0 / -	28.5 / -	45.0 / 42.0	7.5	380-450
MPS-2125A9D-XX	82, -, 02	2100-2500	14.0/13.0	0.20/0.50	1.4 / 1.5	1.2 / 1.5	5.0 / -	26.0 / 25.0	42.0 / 41.0	7.5	300-400
MPS-213011-XX	82, 85, 02	1700-2100	14.0/13.0	0.25/0.50	1.5 / -	2.2 / -	6.0 / -	29.0 / -	45.0 / 42.0	7.5	380-450
MPS-242717-XX	02	2400-2700	13.0/12.0		2.0 / -	-	-	28.0 / -	45.0 / 42.0	6.0-7.0	380-450
MPS-253011-XX	02, 82, 85, *	2400-2700	13.0/12.0	0.25/0.50	1.5 / -	2.2 / -	6.0 / -	29.0 / -	45.0 / 42.0	7.5	380-450
MPS-343517-XX	02, 82	3400-3500	13.0/12.0	0.25/0.50	2.0 / -	2.2 / -	6.0 / -	29.0 / -	45.0 / 42.0	7.5	380-450
MPS-3435A9D-XX	82, -	3400-3500	13.0/12.0	0.20/0.30	1.4 / 1.5	1.3 / 1.5	6.0 / -	24.0 / 23.0	41.0 / 39.0	7.5	300-400
MPS-343617-XX	82	3400-3600	13.0/12.0		2.0 / -	2.2 / -	-	29.0 / -	48.0 / 44.0	7.5	350-420
MPS-343717-XX	02	3400-3700	12.5/11.7		1.5 / -	2.5 / -	-	28.5 / -	45.0 / 42.0	6.0-7.0	330-400
MPS-343717-XX	82	3400-3700	12.5/11.7		1.5 / -	2.5 / -	-	28.5 / -	45.0 / 42.0	6.7	380-450
MPS-363817-XX	82	3600-3800	13.0/12.0		2.0 / -	2.2 / -	-	29.0 / -	48.0 / 44.0	7.5	350-420
"ULA 808-XX Special Order Only"	82, -	1800-2100	14.0/13.0	0.25/0.50	2.0 / -	2.0 / -	- / -	28.0 / -	48.0 / 46.0	8.0	270-350
"ULA 818-XX Special Order Only"	82, -	800-1000	15.5/14.0	0.25/0.50	1.5 / -	1.5 / -	- / -	28.0 / -	48.0 / 46.0	8.0	270-350

* Hermetic Version Available (96 package)

MPS, ULA, and MGA

General Purpose Hybrid Amplifiers in Surface Mount Packages

Model	Case Code (-XX) Sealed SMT, Flange	Case Code (-XX) Hermetic SMT	Freq Range (MHz)	Linear Gain Typ/Min (dB)	Gain Flatness Typ/Ma (±dB)	VSWR Input Typ/Min	VSWR Output Typ/Min	Noise Figure Typ/Min (dB)	Pout @ -1 dB Typ/Min (dBm)	PAE @ -1 Typ (%)	IP3 Typ/Min (dBm)	DC Voltage Applied (V)	DC Current Typ/Max (mA)
MPS-002701-XX	84	-	00-2700	11.5/10.5	0.5/0.8	2.0 / -	1.8 / -	6.0 / -	20.0 / 19.0	-	35.0 / -	5.0	120 / 160
MPS-003001-XX	84	87	20-3000	11.5/10.5	0.80/1.20	1.6 / 2.5	1.6 / 2.5	4.0* / -	21.0 / 19.0	30*	34.0 / -	5.0	90 / 160
MPS-013001-XX	84	-	100-3000	11.5/10.5	0.80/1.20	1.6 / 2.5	1.6 / 2.5	3.5*/5.0*	21.0 / 19.0	30	34.0 / -	5.0	90 / 160
MPS-032701A-XX	82	96	300-2700	20.0 / -	1.0 / -	2.0 / -	2.0 / -	5.0 / -	20.0 / 19.0	-	34.0 / -	5.0	320 / 360
MPS-0425A9D-XX	82	96	400-2500	14.0/13.0	-	1.4 / 1.7	1.2 / 1.7	-	25.0 / -	-	42.0 / -	7.5	300 / 330
MPS-082508-XX	82, 85	96	800-2500	13.0/11.0	0.50/1.00	2.0 / 2.5	2.0 / 2.5	5.0 / -	27.0 / 26.0	25	38.0/36.0	12.0	200 / 300
MPS-302201-XX	-	87	100-3000	11.5/10.5	0.50/0.80	1.6 / 2.5	1.6 / 2.5	3.5*/5.0*	22.0 / 20.5	30	35.0 / -	5.0	90 / 160
MPAM-206032-05	05	-	200-6000	26/-	1.2/-	1.6 / -	1.5 / -	5.5/-	32 / -	-	-	8/9	230 / 320

* NF - See Data Sheet

WiMAX Hybrid Amplifiers in Surface Mount Packages

Model	Case Code Sealed	Freq Range (MHz)	Linear Gain Typ/Min (dB)	Gain Flatness Typ/Ma (±dB)	VSWR Input Typ	VSWR Output Typ	P1dB Typ (dBm)	Pout @ 2.0% EVM Typ (dBm)	IP3 Typ/Min (dBm)	DC Voltage (V)	DC Current Typ/Max (mA)
WPS-242717-XX	02, 82	2450-2700	13.0	0.30/0.60	1.5	2.5	28.5	22.0	45.0	7.5	330
WPS-252717-XX	82	2500-2700	13.0	0.30/0.60	1.5	2.5	28.5	22.0 (1)	45.0	7.5	300
WPS-252724-XX	02, 99	2500-2700	14.0	0.30/0.60	1.5	2.5	36.0	29.0	50.0	8.5	1200
WPS-303322-XX	02	3000-3300	13.0	0.30/0.60	1.5	2.5	32.0	26.0 (1)	47.0	8.0	600
WPS-343617-XX	82	3400-3600	13.0	0.30/0.60	1.5	2.5	29.0	22.0 (1)	48.0	7.5	380-450
WPS-343717-XX	82	3400-3700	13.0	0.30/0.60	1.5	2.5	29.0	22.0 (1)	45.0	7.5	380-450
WPS-343722-XX	02	3400-3700	13.0	0.30/0.60	1.5	2.5	32.0	26.0 (1)	47.0	8.0	600
WPS-343724-XX	02, 99	3400-3700	14.0	0.30/0.60	1.5	2.5	36.0	29.0	50.0	8.0	1200
WPS-363817-XX	82	3600-3800	13.0	0.30/0.60	1.5	2.5	29.0	22.0 (1)	48.0	7.5	380-450
WPS-444922-XX	02	4400-4900	11.0	0.30/0.60	1.5	2.5	32.0	26.0	47.0	7.5	600
WPS-445122-XX	02	4400-5100	11.0	0.30/0.60	1.5	2.5	32.0	26.0	47.0	7.5	600
WPS-445124-XX	02	4400-5100	10/9	--	2.45	3.0	36 (2)	29.0	50.0	8.5	1200
WPS-495122-XX	02	4900-5100	11.0	0.30/0.60	1.5	2.5	32.0	26.0	47.0	7.5	600
WPS-495917-XX	02	4900-5900	13.0	0.30/0.60	1.5	2.5	28.5	22.0	44.0	7.5	300
WPS-495922-XX	02	4900-5900	11.0	0.30/0.60	1.5	2.5	32.0	26.0	47.0	7.5	600
WPS-545922-XX	02	5400-5900	11.0	0.30/0.60	1.5	2.5	32.0	26.0	47.0	7.5	600

(1) Pout @ 2.5% EVM (2) Pout @ -1dB

WiMAX Linear GaN Amplifiers

Model	Pkg/ Chip	Freq (GHz)	Linear Gain Typ/Min (dB)	Gain Flatness Typ/MAX (±dB)	Input RL Typ (dB)	Output RL Typ (dB)	Pout @ -3 dB Typ/Min (dBm)	Pout @ 2.5% EVM Typ (dBm)	Vdd (V)	DC Current (mA)
MGA-242740-02	02	2.4-2.7	14/12	1.0/1.5	8	8	40	33	28	50-400
MGA-333840-02	02	3.3-3.8	15/12	1.0/1.5	8	8	40	33	28	100-400
MGA-495940-02	02	4.9-5.9	12 / 10	1.0/1.5	8	8	40	33	28	100-400
MGA-444940-02	02	4.4-4.9	12 / 10	1.0/1.5	8	10	40	33	28	100-400
MGA-445343-99	99	4.4-5.3	14/12	1.0/1.5	7	4	43	35	28	150-300

Standard, Military, and Hi-Rel Connectorized Amplifiers



Wide-Band Amplifiers

Model Number	Freq Range (GHz)	Linear Gain Min/Typ (dB)	Gain Flatness Max (±dB)	Noise Figure Max/Typ (dB)	Pout -1 dB Min/Typ (dBm)	Current @12 V MAX * (mA)	Case Code
AW052202N	0.5-2	30/33	1.4	2.5/2.2	15/17	300	SL-2
AW052203	0.5-2	23/26	1.0	3.0/2.5	17/19	260	SL-2
AW054201N	0.5-4	19/26	1.0	2.5/2.2	15/17	220	SL-2
AW054203	0.5-4	21/24	1.0	4.5/4.0	16/18	260	SL-2
AW12201N	1-2	28/31	1.1	2.5/2.2	18/20	225	SL-2
AW12203	1-2	27/30	1.1	3.5/3.0	27/28	555	SL-2
AW26201N	2-6	21/23	1.0	2.5/2.2	13/15	155	SL-2
AW26204	2-6	19/21	1.0	4.5/4.0	23/24	335	SL-2
AW28201N	2-8	29/32	1.5	3.0/2.5	13/15	175	SL-2
AW28302	2-8	31/33	1.5	5.5/5.0	23/24	615	SL-3
AW612301N	6-12	30/32	1.0	3.5/3.0	16/17	240	SH-3
AW612304	6-12	22/23	1.0	6.5/6.0	27/28	750	SH-4
AW1218301N	12-18	24/26	0.8	3.5/3.0	14/15	230	SH-3
AW1218504	12-18	29/31	1.3	7.5/7.0	27/28	1200	SH-6
AW818301N	8-18	24/26	1.0	3.5/3.0	14/15	230	SH-3
AW818504	8-18	29/32	1.5	7.5/7.0	27/28	1300	SH-6
AW618301N	6-18	24/26	1.3	3.5/3.0	14/15	230	SH-3
AW618302	6-18	19/21	1.3	6.0/5.5	20/21	350	SH-3
AW618404	6-18	20/22	1.5	7.5/7.0	27/28	1200	SH-5
AW218201N	2-18	25/28	1.8	5.0/4.5	6/7	135	SH-2
AW218301N	2-18	24/26	2.0	6.5/6.0	15/16	365	SH-3
AW218301	2-18	20/22	2.0	6.0/5.5	20/21	500	SH-3

Temperature Compensation Amplifiers

Model Number	Freq Range GHz	Linear Gain MIN/TYP (dB)	Gain Flatness MAX (±dB)	Noise Figure MAX/TYP (dB)	Gain vs. Temp MAX (±dB)	Current @12 V MAX * (mA)	Case Code
AT26301	2-6	21/23	1.0	6.0/5.5	0.8	300	SL-3
AT26401	2-6	36/40	1.5	5.5/5.0	1.0	470	SL-4
AT618401	6-18	22/24	1.0	7.5/7.0	0.8	380	SH-4
AT618501	6-18	31/33	1.3	7.0/6.5	0.8	500	SH-5

Limiting Amplifiers

Model Number	Freq Range (GHz)	Pin Dynamic MIN/MAX (dBm)	Noise Power MAX (dBm)	Pout-sat MIN/MAX (dBm)	Pout MAX Flatness (±dB)	Current @12 V MAX * (mA)	Case Code
AL26501	2-6	-50/10	7.0	+15/+20	1.0	500	SL-5
AL618801	6-18	-50/10	10.0	+15/+20	2.0	800	LH-44

Contact factory for application assistance on custom and standard amplifiers. Hi-Rel and Space-Rel screening are available.
* Built in voltage regulator.

Standard, Military, and Hi-Rel Connectorized Amplifiers

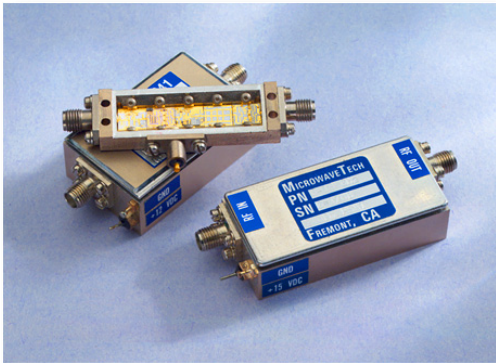
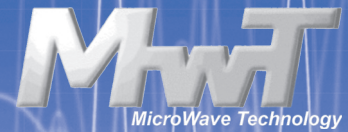

Low Noise Amplifiers

Model Number	Freq Range GHz	Linear Gain MIN (dB)	Gain Flatness MAX (±dB)	Noise Figure MAX/TYP (dB)	Pout-1dB MIN/TYP (dBm)	Current @12 V MAX * (mA)	Case Code
AN12201N	1.2-1.8	28/31	0.5	-/1.7	15/17	180	CL-1
AN23201N	2.2-2.9	28/31	0.5	-/1.7	15/17	180	CL-1
AN45201N	4.4-5.0	25/27	0.5	-/1.7	15/17	180	CL-1
AN78201N	7.2-7.8	23/25	0.5	-/1.8	14/16	150	CH-1
AN910201N	9.0-10.0	21/23	0.5	-/1.8	14/16	150	CH-1
AN1415301N	14.5-15.3	24/27	0.5	-/2.1	13/15	200	CH-3
AN1718401N	17.7-18.7	29/32	1.0	-/2.8	12/14	250	CH-3

Medium Power Amplifiers

Model Number	Freq Range (GHz)	Linear Gain MIN (dB)	Gain Flatness MAX ±dB	VSWR MAX In/Out	Pout-1dB MIN/TYP (dBm)	Current @12 V MAX * (mA)	Case Code
AP45401	4.4-5.0	35.0	0.6	1.5/1.5	30.0/30.5	1400	CL-3
AP67402	5.9-6.4	33.0	0.6	1.5/1.5	33.0/33.5	2700	CL-3
AP78401	7.2-8.4	33.0	0.8	1.5/1.5	30.0/30.5	1450	CH-3
AP910401	9.0-10.0	32.0	0.8	1.5/1.5	30.0/30.5	1450	CH-3
AP1011401	10.7-11.7	27.0	0.8	1.5/1.5	30.0/30.5	1550	CH-3
AP1415401	14.0-14.5	23.0	0.5	1.5/1.5	29.0/30.0	1700	CH-3
AP1718501	17.7-18.7	24.0	1.0	1.8/1.8	26.0/27.0	1250	CH-5

Telecom Power Amplifiers

Model Number	Freq Range (GHz)	Linear Gain MIN (dB)	Gain Flatness MAX (±dB)	IMD3 (dBc) @ Po (dBm/Tone)	Pout-1dB MIN/TYP (dBm)	Current @12 V MAX * (mA)	Case Code
AP1819701	18.1-18.6	30	0.5	-50@+15	27	2300	PH-01
AP1819801	18.1-18.6	35	0.5	-54@+15	29	2700	PH-01

Contact factory for application assistance on custom and standard amplifiers. Hi-Rel and Space-Rel screening are available.

* Built in voltage regulator.

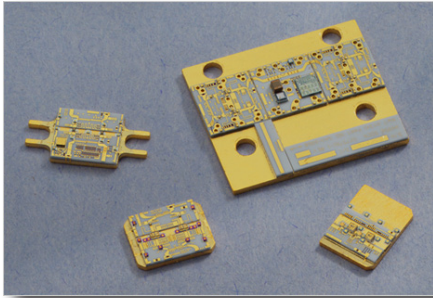

MwT Standard and Custom Hybrid Modules

Standard Gain Block Modules

Model	Freq Range (GHz)	Linear Gain Typ/Min (dB)	Gain Flatness Typ/Max (±dB)	VSWR: 1 In & Out Typ/Max	Reverse Isolation Typ (dB)	Noise Figure Typ (dB)	Pout @ -1 dB Typ/Min (dBm)	IP3 Typ	Current @ +8 V Typ/Max (mA)	Case Code	Carrier Size (mil x mil)
MwT 0206-11P2	2.0-6.0	6.0 / 5.0	0.4 / 0.6	1.7 / 2.0	-18.0	7.0	30.0 / 29.5	41.0	850 / 950	S/Z-1	300 • 600
MwT 0206-1G1	2.0-6.0	16.0 / 15.0	0.6 / 0.6	1.8 / 2.0	-30.0	4.5	17.0 / 16.0	27.0	150 / 180	U/L-1	300 • 600
MwT 0206-1G2	2.0-6.0	18.0 / 17.0	0.5 / 0.6	1.8 / 2.0	-30.0	3.5	19.0 / 18.0	29.0	150 / 200	U/L-1	300 • 600
MwT 0206-2P2	2.0-6.0	10.5 / 10.0	0.4 / 0.6	1.5 / 1.8	-20.0	4.5	24.5 / 24.0	35.0	220 / 260	S/Z-1	300 • 600
MwT 0206-7G2	2.0-6.0	11.0 / 10.5	0.4 / 0.6	1.5 / 1.8	-20.0	3.0	15.0 / 14.0	25.0	60 / 80	S/Z-1	300 • 600
MwT 0206-9P2	2.0-6.0	11.0 / 10.0	0.4 / 0.6	1.7 / 2.0	-20.0	4.0	26.0 / 25.0	37.0	260 / 290	S/Z-1	300 • 600
MwT 0206-A9G1	2.0-6.0	17.0 / 16.0	0.5 / 0.6	1.8 / 2.0	-30.0	1.5	15.0 / 14.0	25.0	50 / 55	S/Z-1	300 • 600
MwT 0206-A9N2	2.0-6.0	15.0 / 12.5	2.0 / 2.5	1.7 / 2.0	-17.0	1.0	15.0 / 13.0	25.0	50 / 70	S/Z-1	300 • 600
MwT 0618-2P1	6.0-18.0	5.0 / 4.5	0.4 / 0.6	1.5 / 1.7	-20.0	7.0	24.8 / 24.0	35.0	200 / 250	S/Z-2	250 • 500
MwT 0618-2P2	6.0-18.0	5.5 / 5.0	0.3 / 0.5	1.5 / 1.7	-20.0	7.0	25.5 / 24.5	36.0	220 / 275	S/Z-2	250 • 500
MwT 0618-3P1	6.0-18.0	6.0 / 5.0	0.4 / 0.6	1.5 / 1.7	-20.0	6.5	20.5 / 20.0	30.0	100 / 120	S/Z-2	250 • 500
MwT 0618-3P2	6.0-18.0	6.5 / 6.0	0.3 / 0.5	1.5 / 1.7	-20.0	6.5	21.5 / 21.0	31.0	100 / 120	S/Z-2	250 • 500
MwT 0618-4N1	6.0-18.0	7.5 / 7.0	0.4 / 0.6	1.5 / 1.7	-20.0	4.5	14.0 / 12.0	25.0	40 / 60	S/Z-2	250 • 500
MwT 0618-4N2	6.0-18.0	8.0 / 7.5	0.4 / 0.6	1.5 / 1.7	-20.0	4.0	14.0 / 11.0	25.0	40 / 60	S/Z-2	250 • 500
MwT 0618-H4N2	6.0-18.0	9.0 / 8.5	0.4 / 0.6	1.5 / 1.7	-20.0	3.0	10.0 / 7.0	20.0	40 / 60	S/Z-2	250 • 500
MwT 0618-5G1	6.0-18.0	10.0 / 9.5	0.4 / 0.6	1.5 / 1.7	-30.0	5.5	16.0 / 14.0	26.0	90 / 100	S/Z-2	250 • 500
MwT 0618-5G2	6.0-18.0	10.5 / 10.0	0.4 / 0.6	1.5 / 1.7	-30.0	5.0	18.0 / 15.5	28.0	100 / 120	S/Z-2	250 • 500
MwT 0618-7G2	6.0-18.0	7.5 / 7.0	0.4 / 0.6	1.5 / 1.7	-20.0	5.0	15.0 / 14.0	25.0	60 / 80	S/Z-2	250 • 500
MwT 0618-12P2	6.0-18.0	4.6 / 4.2	0.4 / 0.6	1.5 / 1.7	-20.0	7.5	27.5 / 27.0	38.0	350 / 450	S/Z-2	250 • 500
MwT 0618-H15P2	6.0-18.0	8.5 / 7.5	0.4 / 0.6	1.5 / 1.7	-20.0	7.5	27.0 / 26.0	34.0	250 / 275	S/Z-2	250 • 500
MwT 0618-H15P3	6.0-18.0	7.5 / 6.5	0.4 / 0.6	1.5 / 1.7	-20.0	7.5	29.0 / 28.0	36.0	250 / 300	S/Z-2	250 • 500
MwT 0618-H16P3	6.0-18.0	5.0 / 6.0	0.8 / 1.2	1.7 / 2.0	-17.0	8.0	30.0 / 29.0	38.0	450 / 550	S/Z-2	250 • 500
MwT 0618-H5G2	6.0-18.0	15.0 / 14.0	0.5 / 1.0	1.7 / 2.0	-17.0	3.0	20.0 / 17.0	29.0	80 / 120	S/Z-2	250 • 500
MwT 0618-H7P2	6.0-18.0	9.0 / 9.5	0.5 / 1.0	1.7 / 2.0	-17.0	5.5	21.0 / 24.0	33.0	110 / 150	S/Z-2	250 • 500
MwT 0820-3P1	8.0-20.0	5.0 / 4.5	0.4 / 0.6	1.5 / 1.7	-20.0	7.5	19.0 / 18.0	29.0	100 / 120	S/Z-2	250 • 500
MwT 0820-3P2	8.0-20.0	5.5 / 5.0	0.4 / 0.6	1.5 / 1.7	-20.0	7.0	20.0 / 19.0	29.0	100 / 120	S/Z-2	250 • 500
MwT 0820-4N1	8.0-20.0	6.0 / 5.5	0.4 / 0.6	1.5 / 1.7	-20.0	8.0	14.0 / 12.0	25.0	40 / 60	S/Z-2	250 • 500
MwT 0820-4N2	8.0-20.0	6.5 / 6.0	0.4 / 0.6	1.5 / 1.7	-20.0	4.0	14.0 / 11.0	25.0	40 / 60	S/Z-2	250 • 500
MwT 0820-5G1	8.0-20.0	9.0 / 8.0	0.4 / 0.6	1.5 / 1.7	-28.0	4.0	16.0 / 14.0	26.0	90 / 110	S/Z-2	250 • 500
MwT 0218-4N1	2.0-18.0	6.0 / 5.0	0.8	1.7 / 2.0	-20.0	7.0	15.0 / 14.0	25.0	100 / 120	S/Z-2	250 • 500
MwT 0218-4N2	2.0-18.0	6.5 / 6.0	1.2	1.7 / 2.0	-20.0	8.5	17.0 / 16.0	26.0	160 / 180	S/Z-2	250 • 500
MwT 0218-H4N1	2.0-18.0	12.0 / 11.0	0.8	1.7 / 2.0	-20.0	4.0	6.0 / 5.0	15.0	40 / 50	S/Z-2	250 • 500
MwT 0218-H4N2	2.0-18.0	11.0 / 10.0	0.8	1.7 / 2.0	-20.0	4.0	12.0 / 11.0	24.0	60 / 75	S/Z-2	250 • 500

Note: Typical 2nd Harmonics @ P-1 -21.0 dBc Typ

Voltage Regulator Modules

Model	Freq Range (GHz)	Insertion Loss Typ/Max (dB)	Ripple Rej @ 120 Hz Min (dB)	Pw Diss Per VR Max (Watts)	Regulated Voltage Min/Max (V)	Supply Voltage Typ/Min (V)	Total Current Max (mA)	Case Code	Carrier Size (mil x mil)
MwT 0206-VRM	2.0-6.0	- / 0.5	50.0	1.5	7.9 / 8.1	12.0 / 20.0	800	U/L-1	300 • 600
MwT 0618-VRM	6.0-18.0	- / 1.0	50.0	1.5	7.9 / 8.1	12.0 / 20.0	800	U/L-2	250 • 500

MwT Standard Voltage Regulator Modules (Each Module Contains Dual Adjustable Voltage Regulators)

Temperature Compensation Modules

Model	Freq Range (GHz)	Insertion Loss Typ/Max (dB)	Loss Flatness ±Max (dB)	Attend. Typ/Min (dB)	Current @ +8 V Max (mA)	Case Code	Carrier Size (mil x mil)
MwT 0206-TCM	2.0-6.0	1.0 / 2.5	0.4 / 0.6	13.0 / 12.0	10 / 20	S/Z-1	300 • 600
MwT 0618-TCM	6.0-18.0	2.5 / 3.0	0.4 / 0.6	13.0 / 12.0	10 / 20	S/Z-2	250 • 500

MwT Standard Temperature Compensation Modules

(Dimensions in mm)

Q4/L4

Notes:
 Units: in/mm
 Ground Pad is 2.0 x 2.0 mm
 Surface Finish: SN Plate
 Tolerances are ± 0.005

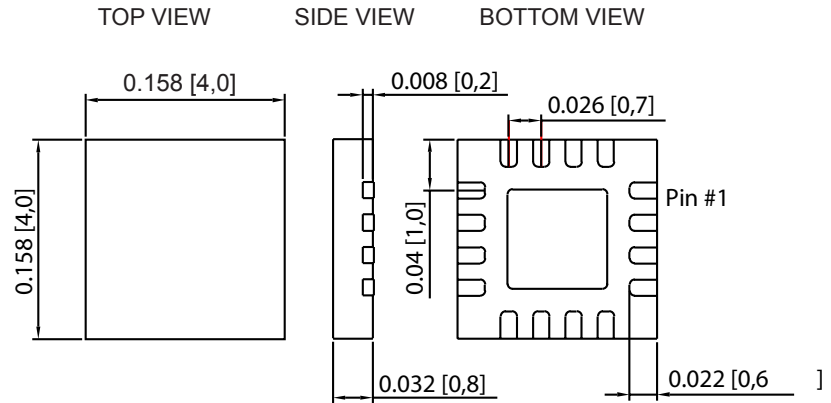

Q5

Notes:
 Units: in/mm
 Ground Pad is 3.65 x 3.65 mm

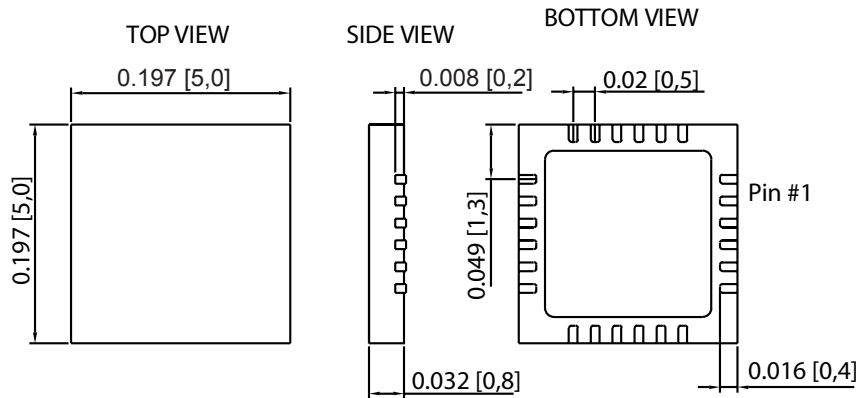

Q10

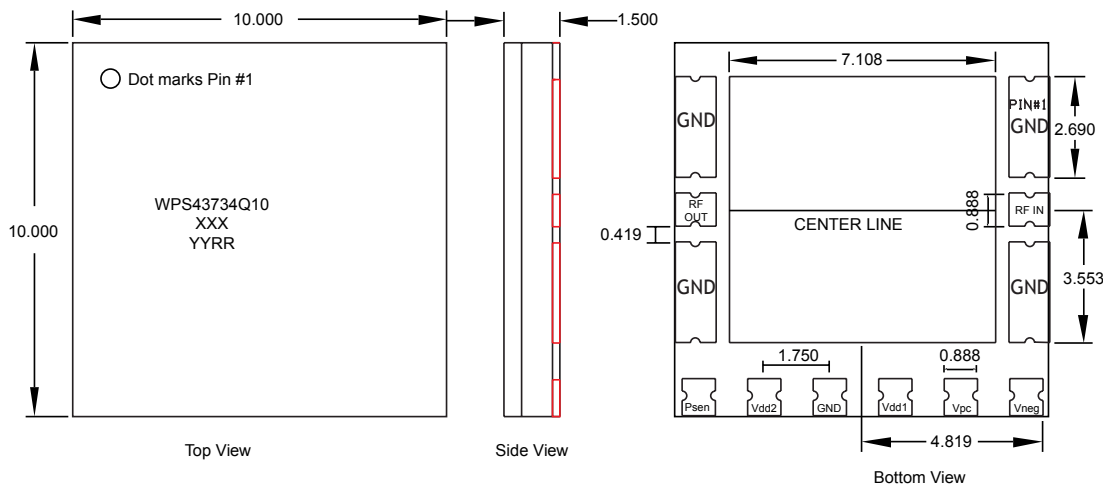

Pin Assignment	
Pin #	Name
1	GND
2	RF In
3	GND
4	Vneg
5	Vpc
6	Vdd1
7	GND
8	Vdd2
9	Psen
10	GND
11	RF Out
12	GND

Dimensions are in mm
 Tolerance is +/- 0.2 mm

(Dimensions in mm and inches – 1mm = 0.0394”)

Package 02

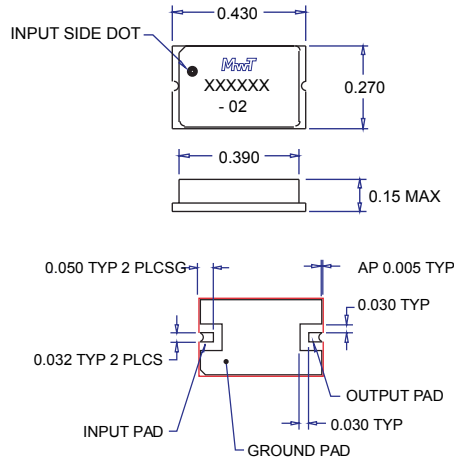

Package 05

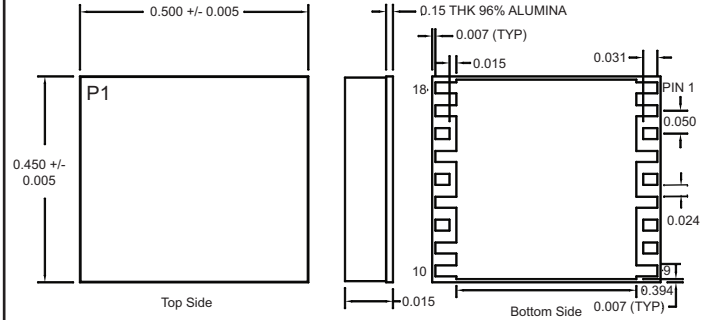

Notes:

1. Plated with 0.002” of Cu and 150m” of Ni.
2. Backside Gold Finish 4-10u” Au

Package 10

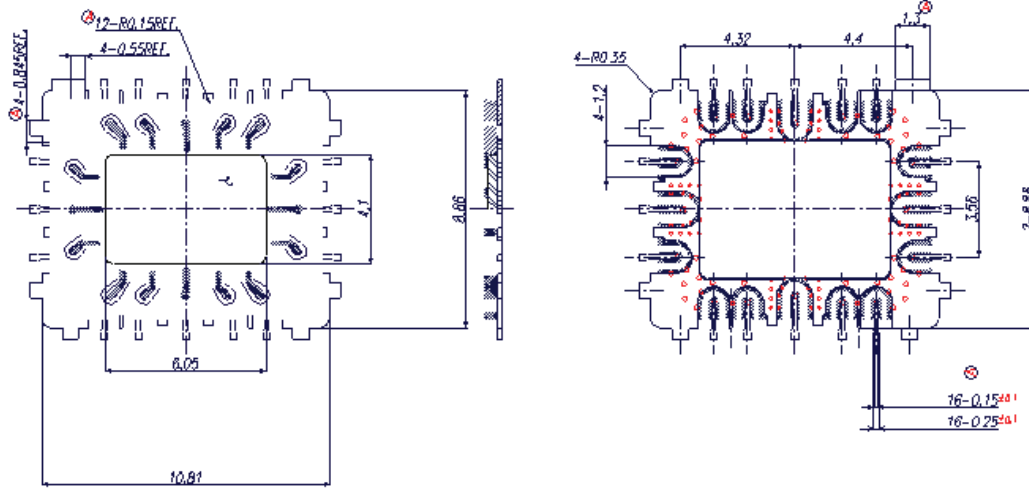

Package 70

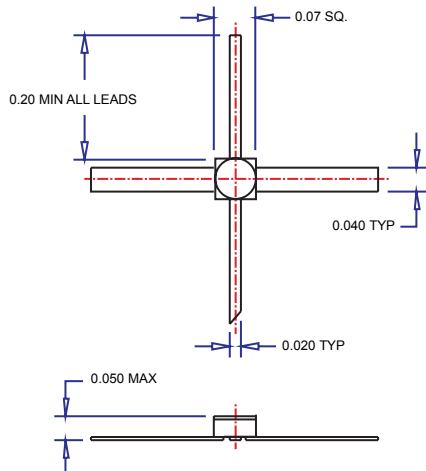

Package 71

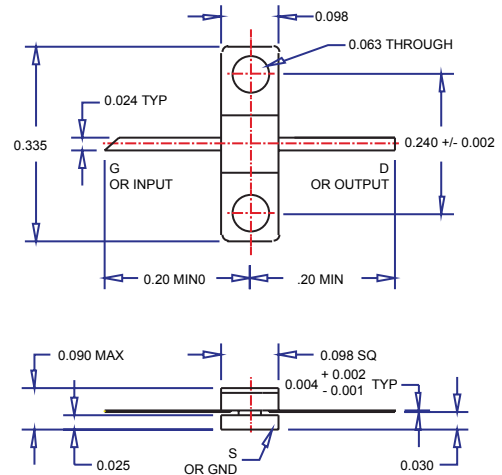

Outline Drawings

(Dimensions in mm and inches – 1mm = 0.0394”)

Package 73

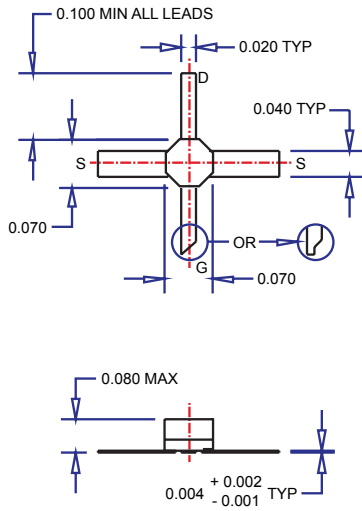

Package 81

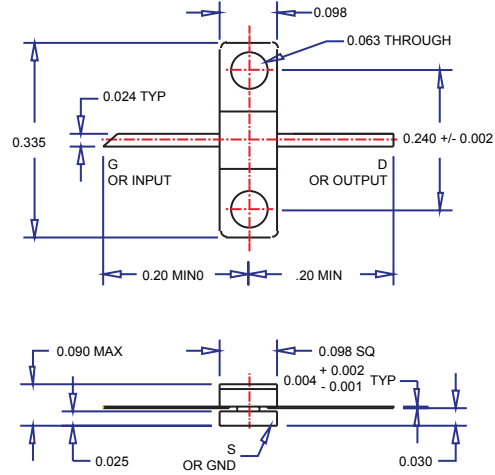

Package 82

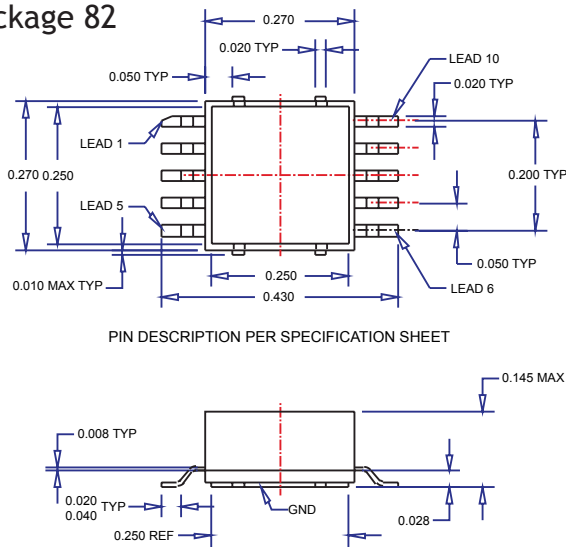

Package 84

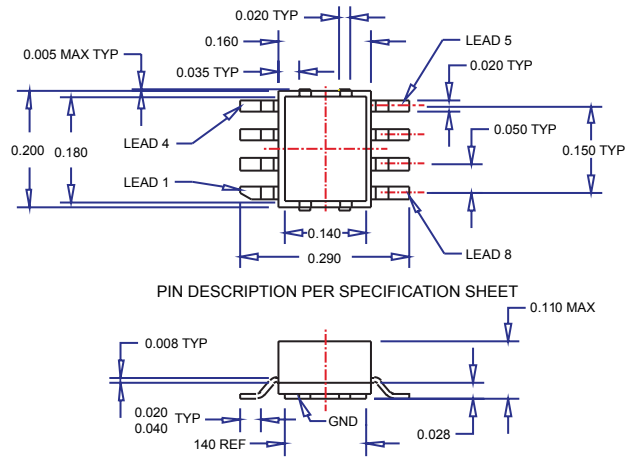

Package 85

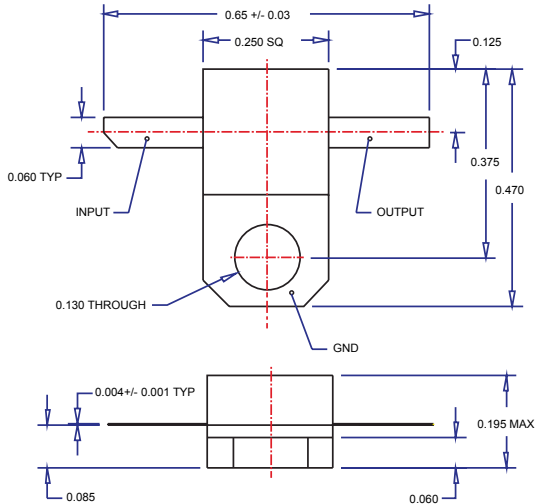

Package 87

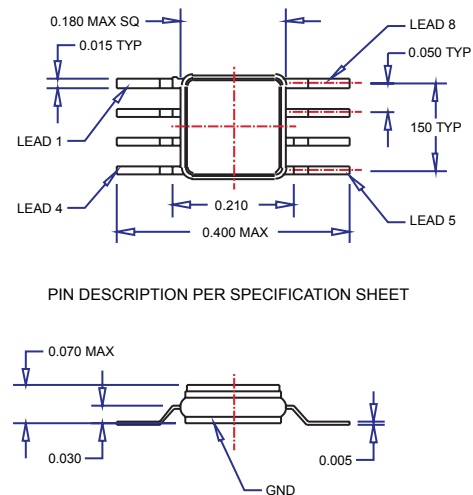

(Dimensions in mm and inches – 1mm = 0.0394”)

Outline Drawings

Package 88

Notes:

- Package body sizes exclude mold flash and gate burrs
- Dimension L is measures in gage plane
- Tolerance 0.10mm unless otherwise specified
- Controlling dimension is millimeter.
- Converted inch dimensions are not necessarily exact
- Followed from Jedec MS-012
- Thermal slug dimension: 75mils x 100mils

SYMBOLS	DIMENSIONS IN MILLIMETERS			DIMENSIONS IN INCHES		
	MIN	NOM	MAX	MIN	NOM	MAX
A	1.45	1.50	1.55	0.057	0.059	0.061
A1	0.00	---	0.15	0.000	---	0.006
A2	---	1.45	---	---	0.057	---
B	0.33	---	0.51	0.013	---	0.020
C	0.19	---	0.25	0.007	---	0.010
D	4.80	---	5.00	0.189	---	0.197
E	3.80	---	4.00	0.150	---	0.157
e	---	1.27	---	---	0.050	---
H	5.80	---	6.20	0.228	---	0.244
L	0.40	---	1.27	0.016	---	0.050
y	---	---	0.10	---	---	0.004
θ	0°	---	8°	0°	---	8°

Package 89 (SOT-89)

Package 96

Package 99

Contact Information

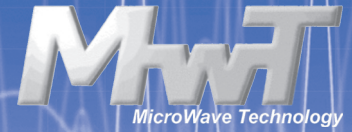

MicroWave Technology Inc.
4268 Solar Way
Fremont, CA 94538
Phone: (510) 651-6700
Fax: (510) 952-4000
Website: www.mwtinc.com
sales@mwtinc.com
An IXYS Subsidiary

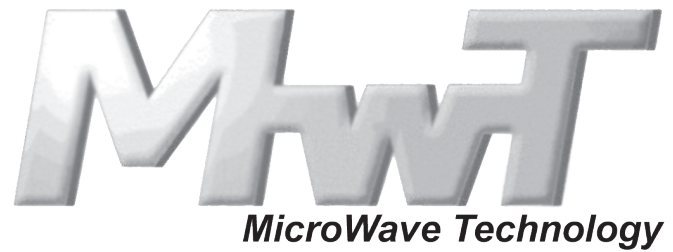

MwT Headquarters in Fremont, California, USA